



FLEX I/O 48V DC Digital Input and Output Modules

Catalog numbers 1794-IC16, 1794-OC16

Table of Contents

Topic	Page
Important User Information	2
Environment and Enclosure	3
Preventing Electrostatic Discharge	3
European Hazardous Location Approval	5
North American Hazardous Location Approval	7
Install Your 48V DC Digital Input or Output Module	8
Connect Wiring for the 1794-IC16 or 1794-OC16	9
Configure Your 48V DC Output Module, 1794-OC16	14
Specifications	14

Important User Information

Solid state equipment has operational characteristics differing from those of electromechanical equipment. Safety Guidelines for the Application, Installation and Maintenance of Solid State Controls (Publication [SGI-1.1](#) available from your local Rockwell Automation Sales Office or online at <http://www.rockwellautomation.com/literature/>) describes some important differences between solid state equipment and hard-wired electromechanical devices. Because of this difference, and also because of the wide variety of uses for solid state equipment, all persons responsible for applying this equipment must satisfy themselves that each intended application of this equipment is acceptable.

In no event will Rockwell Automation, Inc. be responsible or liable for indirect or consequential damages resulting from the use or application of this equipment.

The examples and diagrams in this manual are included solely for illustrative purposes. Because of the many variables and requirements associated with any particular installation, Rockwell Automation, Inc. cannot assume responsibility or liability for actual use based on the examples and diagrams.

No patent liability is assumed by Rockwell Automation, Inc. with respect to use of information, circuits, equipment, or software described in this manual.

Reproduction of the contents of this manual, in whole or in part, without written permission of Rockwell Automation, Inc. is prohibited.

Throughout this manual, when necessary, we use notes to make you aware of safety considerations.



WARNING: Identifies information about practices or circumstances that can cause an explosion in a hazardous environment, which may lead to personal injury or death, property damage, or economic loss.



ATTENTION: Identifies information about practices or circumstances that can lead to personal injury or death, property damage, or economic loss. Attentions help you identify a hazard, avoid a hazard, or recognize the consequence.

IMPORTANT

Identifies information that is critical for successful application and understanding of the product.

Environment and Enclosure



ATTENTION: This equipment is intended for use in a Pollution Degree 2 industrial environment, in overvoltage Category II applications (as defined in EN/IEC 60664-1), at altitudes up to 2000 m (6562 ft) without derating.

This equipment is not intended for use in residential environments and may not provide adequate protection to radio communication services in such environments.

This equipment is supplied as open-type equipment for indoor use. It must be mounted within an enclosure that is suitably designed for those specific environmental conditions that will be present and appropriately designed to prevent personal injury resulting from accessibility to live parts. The enclosure must have suitable flame-retardant properties to prevent or minimize the spread of flame, complying with a flame spread rating of 5VA or be approved for the application if nonmetallic. The interior of the enclosure must be accessible only by the use of a tool. Subsequent sections of this publication may contain more information regarding specific enclosure type ratings that are required to comply with certain product safety certifications.

In addition to this publication, see the following:

- Industrial Automation Wiring and Grounding Guidelines, Rockwell Automation publication [1770-4.1](#), for more installation requirements.
- NEMA Standard 250 and EN/IEC 60529, as applicable, for explanations of the degrees of protection provided by enclosures.

Preventing Electrostatic Discharge



ATTENTION: This equipment is sensitive to electrostatic discharge, which can cause internal damage and affect normal operation. Follow these guidelines when you handle this equipment:

- Touch a grounded object to discharge potential static.
 - Wear an approved grounding wriststrap.
 - Do not touch connectors or pins on component boards.
 - Do not touch circuit components inside the equipment.
 - Use a static-safe workstation, if available.
 - Store the equipment in appropriate static-safe packaging when not in use.
-

4 FLEX I/O 48V DC Digital Input and Output Modules



ATTENTION: This product is grounded through the DIN rail to chassis ground. Use zinc plated chromate-passivated steel DIN rail to assure proper grounding. The use of other DIN rail materials (for example, aluminum or plastic) that can corrode, oxidize, or are poor conductors, can result in improper or intermittent grounding. Secure DIN rail to mounting surface approximately every 200 mm (7.8 in.) and use end-anchors appropriately. Be sure to ground the DIN rail properly.

ATTENTION: Refer to Industrial Automation Wiring and Grounding Guidelines, Rockwell Automation publication [1770-4.1](#), for more information.



ATTENTION: If this equipment is used in a manner not specified by the manufacturer, the protection provided by the equipment may be impaired.



ATTENTION: If this equipment is used in a manner not specified by the manufacturer, the protection provided by the equipment may be impaired.

ATTENTION: Read this document and the documents listed in the Additional Resources section about installation, configuration, and operation of this equipment before you install, configure, operate, or maintain this product. Users are required to familiarize themselves with installation and wiring instructions in addition to requirements of all applicable codes, laws, and standards.

ATTENTION: Installation, adjustments, putting into service, use, assembly, disassembly, and maintenance are required to be carried out by suitably trained personnel in accordance with applicable code of practice.

In case of malfunction or damage, no attempts at repair should be made. The module should be returned to the manufacturer for repair. Do not dismantle the module.

ATTENTION: Use only a soft dry anti-static cloth to wipe down equipment. Do not use any cleaning agents.



WARNING: When you insert or remove the module while backplane power is on, an electric arc can occur. This could cause an explosion in hazardous location installations.

Be sure that power is removed or the area is nonhazardous before proceeding. Repeated electric arcing causes excessive wear to contacts on both the module and its mating connector. Worn contacts may create electrical resistance that can affect module operation.

European Hazardous Location Approval

The following modules are European Zone 2 approved: 1794-IC16, 1794-OC16.

The following applies to products marked C E II 3 G:

Are Equipment Group II, Equipment Category 3, and comply with the Essential Health and Safety Requirements relating to the design and construction of such equipment given in Annex II to EU Directive 2014/34/EU. See the EU Declaration of Conformity at <http://www.rockwellautomation.com/global/certification/overview.page> for details.

The type of protection is II 3G Ex nA IIC T3 Gc according to EN 60079-15.

Comply to Standards EN 60079-0:2012, EN 60079-15:2010, reference certificate number LCIE 01 ATEX 6020 X.

Are intended for use in areas in which explosive atmospheres caused by gases, vapors, mists, or air are unlikely to occur, or are likely to occur only infrequently and for short periods. Such locations correspond to Zone 2 classification according to ATEX directive 2014/34/EU.





WARNING: Observe the following additional certification requirements:

- This equipment is not resistant to sunlight or other sources of UV radiation.
 - This equipment shall be mounted in an ATEX/IECEx Zone 2 certified enclosure with a minimum ingress protection rating of at least IP54 (in accordance with EN/IEC 60079-15) and used in an environment of not more than Pollution Degree 2 (as defined in EN/IEC 60664-1) when applied in Zone 2 environments. The enclosure must be accessible only by the use of a tool.
 - This equipment shall be used within its specified ratings defined by Rockwell Automation.
 - The instructions in the user manual shall be observed.
 - This equipment must be used only with ATEX certified Rockwell Automation backplanes.
 - Earthing is accomplished through mounting of modules on rail.
 - Devices shall be used in an environment of not more than Pollution Degree 2.
 - Enclosure must be marked with the following: "Warning - Do not open when energized." After installation of equipment into the enclosure, access to termination compartments shall be dimensioned so that conductors can be readily connected.
-

North American Hazardous Location Approval

The 1794-IC16, 1794-OC16 module is Hazardous Location approved:

The following information applies when operating this equipment in hazardous locations:	Informations sur l'utilisation de cet équipement en environnements dangereux:
<p>Products marked "CL I, DIV 2, GP A, B, C, D" are suitable for use in Class I Division 2 Groups A, B, C, D, Hazardous Locations and nonhazardous locations only. Each product is supplied with markings on the rating nameplate indicating the hazardous location temperature code. When combining products within a system, the most adverse temperature code (lowest "T" number) may be used to help determine the overall temperature code of the system. Combinations of equipment in your system are subject to investigation by the local Authority Having Jurisdiction at the time of installation.</p>	<p>Les produits marqués "CL I, DIV 2, GP A, B, C, D" ne conviennent qu'à une utilisation en environnements de Classe I Division 2 Groupes A, B, C, D dangereux et non dangereux. Chaque produit est livré avec des marquages sur sa plaque d'identification qui indiquent le code de température pour les environnements dangereux. Lorsque plusieurs produits sont combinés dans un système, le code de température le plus défavorable (code de température le plus faible) peut être utilisé pour déterminer le code de température global du système. Les combinaisons d'équipements dans le système sont sujettes à inspection par les autorités locales qualifiées au moment de l'installation.</p>
<div style="display: flex; align-items: center;">  <div> <p>WARNING: EXPLOSION HAZARD</p> <ul style="list-style-type: none"> • Do not disconnect equipment unless power has been removed or the area is known to be nonhazardous. • Do not disconnect connections to this equipment unless power has been removed or the area is known to be nonhazardous. Secure any external connections that mate to this equipment by using screws, sliding latches, threaded connectors, or other means provided with this product. • Substitution of components may impair suitability for Class I, Division 2. </div> </div>	<div style="display: flex; align-items: center;">  <div> <p>WARNING: RISQUE D'EXPLOSION</p> <ul style="list-style-type: none"> • Couper le courant ou s'assurer que l'environnement est classé non dangereux avant de débrancher l'équipement. • Couper le courant ou s'assurer que l'environnement est classé non dangereux avant de débrancher les connecteurs. Fixer tous les connecteurs externes reliés à cet équipement à l'aide de vis, loquets coulissants, connecteurs filetés ou autres moyens fournis avec ce produit. • La substitution de composants peut rendre cet équipement inadapté à une utilisation en environnement de Classe I, Division 2. </div> </div>

Install Your 48V DC Digital Input or Output Module

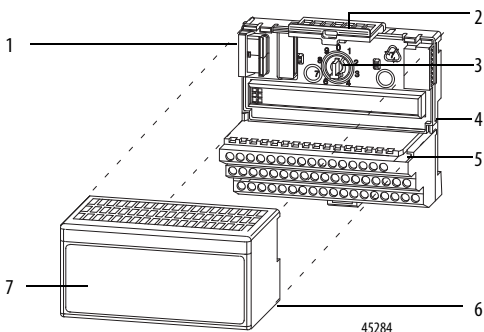

	Description		Description
1	FlexBus connectors	5	Groove
2	Latching mechanism	6	Alignment bar
3	Keyswitch	7	Module
4	Terminal base		

The module mounts on a 1794 terminal base.

1. Rotate the keyswitch (3) on the terminal base (4) clockwise to position 4 as required for this type of module.
2. Make sure the FlexBus connector (1) is pushed all the way to the left to connect with the neighboring terminal base/adapter.
You cannot install the module unless the connector is fully extended.
3. Make sure the pins on the bottom of the module are straight so they will align properly with the connector in the terminal base.
4. Position the module (7) with its alignment bar (6) aligned with the groove (5) on the terminal base.
5. Press firmly and evenly to seat the module in the terminal base unit. The module is seated when the latching mechanism (2) is locked into the module.

Connect Wiring for the 1794-IC16 or 1794-OC16

1. Connect individual input (1794-IC16) or output (1794-OC16) wiring to numbered terminals on the 0...15 row (A) as indicated in the Wiring Connections for 1794-IC16 and 1794-OC16 table.
2. **1794-IC16** – Connect the associated +V DC power lead of the input device to the corresponding terminal on the 34...51 row (C) for each input as indicated in the Wiring Connections for 1794-IC16 and 1794-OC16 table. The +V DC power terminals of row (C) are internally connected together.
3. **1794-OC16** – Connect the associated V DC common lead of the output device to the corresponding terminal on the 16...33 row (B) for each output as indicated in the Wiring Connections for 1794-IC16 and 1794-OC16 table. The V DC common terminals of row (B) are internally connected together.
4. **1794-IC16 only** – Connect the associated input common (3-wire devices only) to the corresponding terminal on the 16...33 row (B) for each input as indicated in the Wiring Connections for 1794-IC16 and 1794-OC16 table. Commons are internally connected together.
5. Connect +V DC power to terminal 34 on the 34...51 row (C).
6. Connect V DC common to terminal 16 on the 16...33 row (B).
7. If daisy chaining power to the next terminal base, connect a jumper from terminal 51 (+V DC) on this base unit to terminal 34 on the next base unit.
8. If continuing V DC common to the next base unit, connect a jumper from terminal 33 (common) on this base unit to terminal 16 on the next base unit.

Wiring Connections for 1794-IC16 and 1794-OC16

1794-IC16				1794-OC16		
Input	1794-TB3, 1794-TB3S			Output	1794-TB2, 1794-TB3, 1794-TB3S	
	Input Terminal	48V DC Supply	Common ⁽¹⁾		Output Terminal	Common
Input 0	A-0	C-35	B-17	Output 0	A-0	B-17
Input 1	A-1	C-36	B-18	Output 1	A-1	B-18
Input 2	A-2	C-37	B-19	Output 2	A-2	B-19
Input 3	A-3	C-38	B-20	Output 3	A-3	B-20

Wiring Connections for 1794-IC16 and 1794-OC16

1794-IC16				1794-OC16		
Input	1794-TB3, 1794-TB3S			Output	1794-TB2, 1794-TB3, 1794-TB3S	
	Input Terminal	48V DC Supply	Common⁽¹⁾		Output Terminal	Common
Input 4	A-4	C-39	B-21	Output 4	A-4	B-21
Input 5	A-5	C-40	B-22	Output 5	A-5	B-22
Input 6	A-6	C-41	B-23	Output 6	A-6	B-23
Input 7	A-7	C-42	B-24	Output 7	A-7	B-24
Input 8	A-8	C-43	B-25	Output 8	A-8	B-25
Input 9	A-9	C-44	B-26	Output 9	A-9	B-26
Input 10	A-10	C-45	B-27	Output 10	A-10	B-27
Input 11	A-11	C-46	B-28	Output 11	A-11	B-28
Input 12	A-12	C-47	B-29	Output 12	A-12	B-29
Input 13	A-13	C-48	B-30	Output 13	A-13	B-30
Input 14	A-14	C-49	B-31	Output 14	A-14	B-31
Input 15	A-15	C-50	B-32	Output 15	A-15	B-32

A = Input/Output terminals

B = Common terminals

C = Power terminals (C-34 to C-51 on 1794-TB3 and 1794-TB3S; C-34 and C-51 on 1794-TB2)

⁽¹⁾ 3-wire devices use input, supply and common. 2-wire devices use input and supply.

1794-TB2, 1794-TB3, and 1794-TB3S Terminal Base Wiring for 1794-IC16 and 1794-OC16

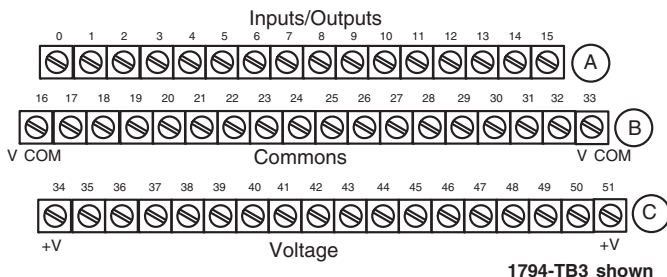

Connect +V DC power to terminal C-34
 Connect V DC common to terminal B-16
 Use B-33 and C-51 for daisy chaining to the next terminal base unit
Note: Terminals C-35...C-50 are not present on the 1794-TB2

2 and 3-Wire Input Wiring for 1794-IC16

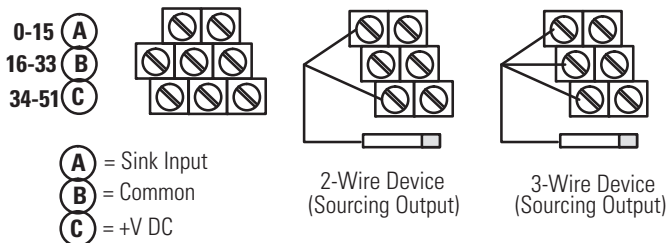

Configuring Your 48V DC Input Module, 1794-IC16

Image Table Memory Map for the 1794-IC16 Module

Dec	15	14	13	12	11	10	9	8	7	6	5	4	3	2	1	0
Oct	17	16	15	14	13	12	11	10	7	6	5	4	3	2	1	0
Read	I15	I14	I13	I12	I11	I10	I9	I8	I7	I6	I5	I4	I3	I2	I1	I0
Write	Not used – set to 0										Input Filter FT1 12...15			Input Filter FT0 0...11		

Where I = Input status
 FT0 = Input filter time for inputs 0...11
 FT1 = Input filter time for inputs 12...15



ATTENTION: This equipment is certified for use only within the surrounding air temperature range of 0...55 °C (32...131 °F). The equipment must not be used outside of this range.

Set the Input Filter Time for the 1794-IC16 Module

The 1794-IC16 has a built-in 1 ms filter. You can increase the input filter time (FT) for channels 0...15. To increase the filter time, set the corresponding bits in the output image table (complementary word) for the module. See the Input Filter Time for 1794-IC16 table.

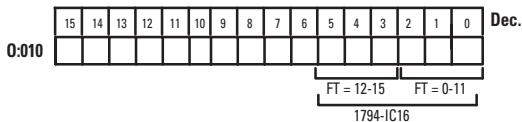

For example, to set an additional filter time of 4 ms for all 16 inputs of a 1794-IC16 module at address rack 1, module group 0, set bits 00...05 as shown below. The result will be a total filter time of 5 ms.

Write filter time on system startup.

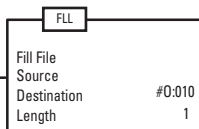

Write FT to complement of input module.

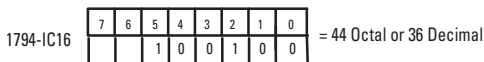

Input Filter Time for 1794-IC16

Actual filter time represents selected filter time plus 1 ms

Bits			Description		
02	01	00	Filter Time for inputs 00...11	Selected Filter Time	Actual Filter Time
05	04	03	Filter Time for inputs 12...15		
0	0	0	Filter Time 0 (Default)	256 μs	1256 μs
0	0	1	Filter Time 1	512 μs	1512 μs
0	1	0	Filter Time 2	1 ms	2 ms
0	1	1	Filter Time 3	2 ms	3 ms
1	0	1	Filter Time 4	4 ms	5 ms
1	0	1	Filter Time 5	8 ms	9 ms
1	1	0	Filter Time 6	16 ms	17 ms
1	1	1	Filter Time 7	32 ms	33 ms

Configure Your 48V DC Output Module, 1794-OC16

Image Table Memory Map for the 1794-OC16 Module

Dec	15	14	13	12	11	10	9	8	7	6	5	4	3	2	1	0
Oct	17	16	15	14	13	12	11	10	7	6	5	4	3	2	1	0
Read	Not used – set to 0															
Write	015	014	013	012	011	010	09	08	07	06	05	04	03	02	01	00
Where	0 = Output															



At the end of its life, this equipment should be collected separately from any unsorted municipal waste.

Specifications

Specifications – 48V DC Input Module 1794-IC16

Attribute	Value
Number of inputs	16, nonisolated, sinking
Recommended terminal base unit	1794-TB3, 1794-TB3S, 1794-TB3K, 1794-TB3SK
On-state voltage, min	30V DC
On-state voltage, nom	48V DC
On-state voltage, max	60V DC
On-state current, min	2.0 mA @ 30V DC
On-state current, nom	5.0 mA @ 48V DC
On-state current, max	7.0 mA @ 60V DC
Off-state voltage, max	10V DC
Off-state current, min	1.5 mA
Nominal input impedance	11 k Ω
Nominal input current	5.0 mA @ 48V DC

Specifications – 48V DC Input Module 1794-IC16

Attribute	Value
Isolation voltage	50V (continuous), Basic Insulation Type Tested at 1900V DC for 1 s, between user and system No isolation between individual channels
Input filter time ⁽¹⁾ Off to On On to Off	Refer to Input Filter Time for 1794-IC16
FlexBus current	25 mA @ 5V DC
Power dissipation, max	6.4 W @ 60V DC
Thermal dissipation, max	21.9 BTU/hr @ 60V DC

⁽¹⁾ Input off-to-on filter time is the time from a valid input signal to recognition by the module. Input on-to-off filter time is time from the input signal dropping below the valid level to recognition by the module.

Specifications – 48V DC Output Module 1794-OC16

Attribute	Value
Number of outputs	16, nonisolated, sourcing
Recommended terminal base unit	1794-TB3, 1794-TB3S, 1794-TB3K, 1794-TB3SK
Output voltage, min	30V DC
Output voltage, nom	48V DC
Output voltage, max	60V DC @ 45 °C 55V DC @ 55 °C
Output current rating	8.0 A (16 outputs @ 0.5 A)
On-state current, min	2.0 mA per channel
On-state current, max	500 mA per channel
Surge current	4 A for 10 ms each, repeatable every 2 s
Off-state voltage, max	60V DC
Off-state leakage, max	1.0 mA
On-state voltage drop, max	1.0V DC @ 0.5 A
Isolation voltage	Type tested at 1900V DC for 1 s, between user and system No isolation between individual channels
Output signal delay, max ⁽¹⁾ Off to On On to Off	0.5 ms 1.0 ms @ 25 °C 2.0 ms @ 55 °C

Specifications – 48V DC Output Module 1794-0C16

Attribute	Value
FlexBus current	80 mA @ 5V DC
Power dissipation, max	3.7 W @ 60V DC
Thermal dissipation, max	12.6 BTU/hr @ 60V DC
Fusing ⁽²⁾	SANO MQ2 – 2A, 150V AC normal blow

⁽¹⁾ Delay time is the time from the receipt of an output on or off command to the output actually turning on or off.

⁽²⁾ Module outputs are not fused. Fusing is recommended. If fusing is desired, you must supply external fusing.

General Specifications

Attribute	1794-1C16	1794-0C16
Terminal base screw torque	Determined by installed terminal base	
Dimensions, approx. (H x W x D)	94 x 94 x 69 mm (3.7 x 3.7 x 2.7 in.)	
Weight, approx.	82 g (2.89 oz.)	110 g (3.88 oz.)
Indicators (field side indication)	16 yellow status indicators (customer device driven)	16 yellow status indicators (logic driven)
External DC power supply voltage, nom	48V DC	
External DC power voltage range	30...60V DC (includes 5% AC ripple)	
External DC power supply current range	51 mA @ 30V DC 82 mA @ 48V DC 107 mA @ 60V DC	13...27 mA
North American temperature code	T3C	T4A
IEC temperature code	T3	T4
Keyswitch position	2	
Enclosure type rating	None (open-style)	
Wire size	Determined by installed terminal base	
Wiring category ⁽¹⁾	2 – on signal ports	

⁽¹⁾ Use this conductor category information for planning conductor routing as described in Industrial Automation Wiring and Grounding Guidelines, publication [1770-4.1](#).

Environmental Specifications

Attribute	Value
Operating temperature	IEC 60068-2-1 (Test Ad, Operating Cold), IEC 60068-2-2 (Test Bd, Operating Dry Heat), IEC 60068-2-14 (Test Nb, Operating Thermal Shock): 0 °C < Ta < +55 °C (+32 °F < Ta < +131 °F)
Temperature, surrounding air, max.	55 °C (131 °F)
Storage temperature	IEC 60068-2-1 (Test Ab, Unpackaged Non-operating Cold), IEC 60068-2-2 (Test Bb, Unpackaged Non-operating Dry Heat), IEC 60068-2-14 (Test Na, Unpackaged Non-operating Thermal Shock): -40...85 °C (-40...185 °F)
Relative humidity	IEC 60068-2-30 (Test Db, Unpackaged Damp Heat): 5...95% non-condensing
Vibration	IEC60068-2-6 (Test Fc, Operating): 5 g @ 10...500 Hz
Shock, operating	IEC60068-2-27 (Test Ea, Unpackaged shock): 30 g
Shock, nonoperating	IEC60068-2-27 (Test Ea, Unpackaged shock): 50 g
Emissions	CISPR 11: Group 1, Class A (with appropriate enclosure)
ESD immunity	IEC 61000-4-2: 6 kV contact discharges 8 kV air discharges
Radiated RF immunity	IEC 61000-4-3: 10V/m with 1 kHz sine-wave 80% AM from 80...2000 MHz 10V/m with 200 Hz 50% Pulse 100% AM @ 900 MHz 10V/m with 200 Hz 50% Pulse 100% AM @ 1890 MHz 1V/m with 1 kHz sine-wave 80% AM from 2000...2700 MHz
EFT/B immunity	IEC 61000-4-4: ±2 kV @ 5 kHz on power ports ±2 kV @ 5 kHz on signal ports
Surge transient immunity	IEC 61000-4-5: ±1 kV line-line(DM) and ±2 kV line-earth(CM) on signal ports
Conducted RF immunity	IEC 61000-4-6: 10V rms with 1 kHz sine-wave 80% AM from 150 kHz...80 MHz

Certifications

Certifications (when product is marked) ⁽¹⁾	Value
c-UL-us	UL Listed Industrial Control Equipment, certified for US and Canada. See UL File E322657. UL Listed for Class I, Division 2 Group A,B,C,D Hazardous Locations, certified for U.S. and Canada. See UL File E334470.
CSA	CSA Certified Process Control Equipment. See CSA File LR93701. CSA Certified Process Control Equipment for Class I, Division 2 Group A,B,C,D Hazardous Locations. See CSA File LR93701.
CE	European Union 2014/30/EU EMC Directive, compliant with: EN 61131-2; Programmable Controllers (Clause 11) EN 61000-6-2; Industrial Immunity EN 61000-6-4; Industrial Emissions EN 61131-2; Programmable Controllers (Clause 8, Zone A & B) European Union 2011/65/EU RoHS, compliant with: EN 50581; Technical documentation
Ex	European Union 2014/34/EU ATEX Directive, compliant with: EN 60079-0; General Requirements EN 60079-15; Potentially Explosive Atmospheres, Protection "n" II 3G Ex nA IIC T3 Gc LCIE 01 ATEX 6020 X
KC	Korean Registration of Broadcasting and Communications Equipment, compliant with: Article 58-2 of Radio Waves Act, Clause 3
EAC	Russian Customs Union TR CU 020/2011 EMC Technical Regulation
RCM	Australian Radiocommunications Act, compliant with: EN 61000-6-4; Industrial Emissions

⁽¹⁾ See the Product Certification link at <http://www.rockwellautomation.com/global/certification/overview.page> for Declarations of Conformity, Certificates, and other certification details.



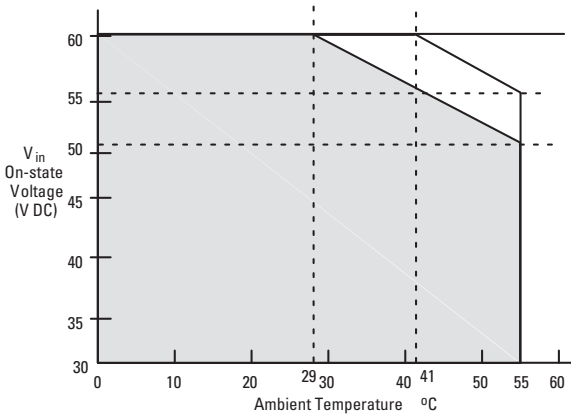

WARNING: When used in a Class I, Division 2, hazardous location, this equipment must be mounted in a suitable enclosure with proper wiring method that complies with the governing electrical codes.

Derating Curve for 1794-IC16



The area within the curve represents the safe operating range for the module under various conditions of user supplied 48V DC supply voltages and ambient temperatures.

-  = Normal mounting safe operating range, (includes ).
 -  = Other mounting positions (including inverted horizontal) safe operating range
- Normal Mounting - Horizontal

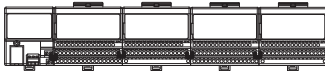

Other Mounting (including Vertical, and Inverted Horizontal Mounting)

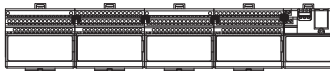

Voltage (max.)	Temperature (max.)	
	Normal	Other
60	41	29
55	55	42
50	55	55

Rockwell Automation Support

Rockwell Automation provides technical information on the Web to assist you in using its products. At <http://www.rockwellautomation.com/support/>, you can find technical manuals, a knowledge base of FAQs, technical and application notes, sample code and links to software service packs, and a MySupport feature that you can customize to make the best use of these tools.

For an additional level of technical phone support for installation, configuration and troubleshooting, we offer TechConnect support programs. For more information, contact your local distributor or Rockwell Automation representative, or visit <http://www.rockwellautomation.com/support/>.

Installation Assistance

If you experience a problem within the first 24 hours of installation, please review the information that's contained in this manual. You can also contact a special Customer Support number for initial help in getting your product up and running.

United States or Canada	1.440.646.3434
Outside United States or Canada	Use the Worldwide Locator at http://www.rockwellautomation.com/support/americas/phone_en.html , or contact your local Rockwell Automation representative.

New Product Satisfaction Return

Rockwell Automation tests all of its products to ensure that they are fully operational when shipped from the manufacturing facility. However, if your product is not functioning and needs to be returned, follow these procedures.

United States	Contact your distributor. You must provide a Customer Support case number (call the phone number above to obtain one) to your distributor to complete the return process.
Outside United States	Please contact your local Rockwell Automation representative for the return procedure.

Documentation Feedback

Your comments will help us serve your documentation needs better. If you have any suggestions on how to improve this document, complete this form, publication [RA-DU002](#), available at <http://www.rockwellautomation.com/literature/>.

Rockwell Automation maintains current product environmental information on its website at <http://www.rockwellautomation.com/rockwellautomation/about-us/sustainability-ethics/product-environmental-compliance.page>.

Allen-Bradley, Rockwell Automation, FLEX I/O, Rockwell Software and TechConnect are trademarks of Rockwell Automation, Inc. Trademarks not belonging to Rockwell Automation are property of their respective companies.

Rockwell Otomasyon Ticaret A.Ş., Kar Plaza İş Merkezi E Blok Kat:6 34752 İçerenköy, İstanbul, Tel: +90 (216) 5698400

www.rockwellautomation.com

Power, Control and Information Solutions Headquarters

Americas: Rockwell Automation, 1201 South Second Street, Milwaukee, WI 53204-2496 USA, Tel: (1) 414-382-2000, Fax: (1) 414-382-4444
Europe/Middle East/Africa: Rockwell Automation NV, Pegasus Park, De Kleetlaan 12a, 1831 Diegem, Belgium, Tel: (32) 2 663 0600, Fax: (32) 2 663 0640
Asia Pacific: Rockwell Automation, Level 14, Core F, Cyberport 3, 100 Cyberport Road, Hong Kong, Tel: (852) 2887-4788, Fax: (852) 2508 1846

Publication 1794-IN105C-EN-P - July 2018

Supersedes Publication 1794-IN105B-EN-P - July 2015

Copyright © 2018 Rockwell Automation, Inc. All rights reserved.